

PLAN

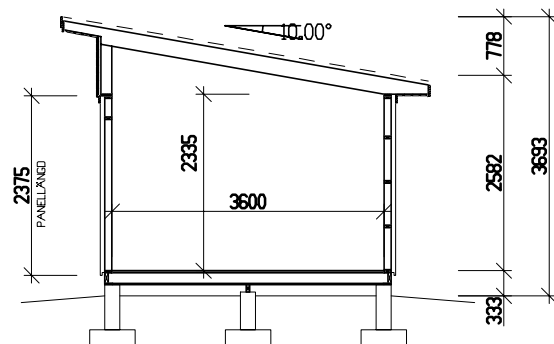

SEKTION

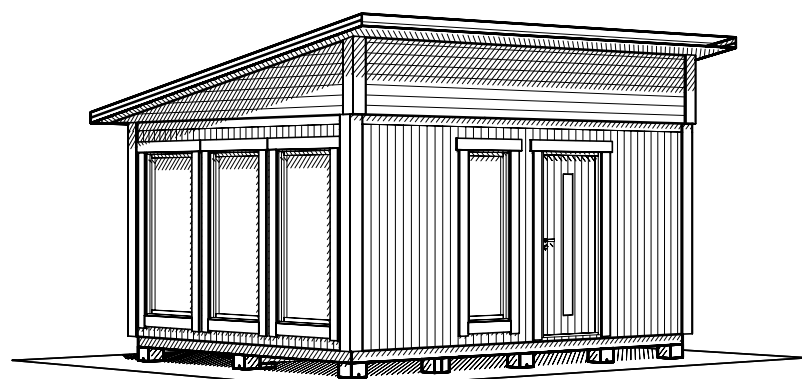

PERSPEKTIV

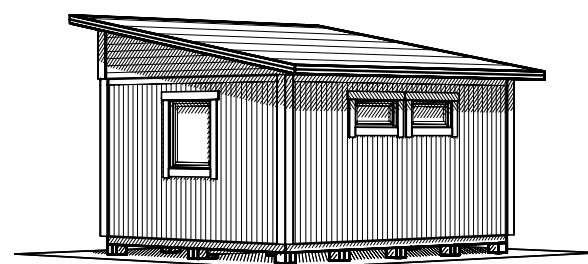

PANEL: FUNKISPANEL 22x120.
 STOMME: 34x95.
 OISLERAT.
 BJÄLKLÄG 45x145.
 GRUNDLÄGGNING: PLINT GRUND.
 LEVERANSOMFATTNING ENLIGT AVTAL.

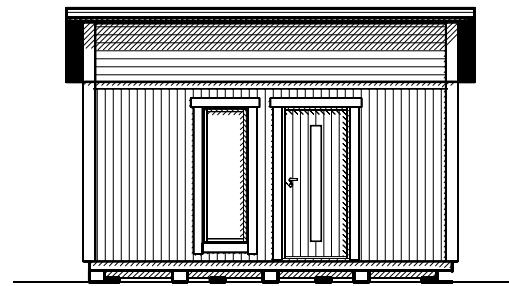

FASAD MOT

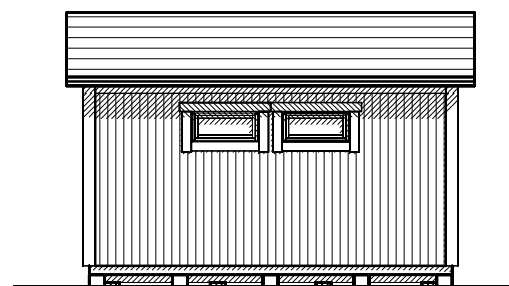

FASAD MOT

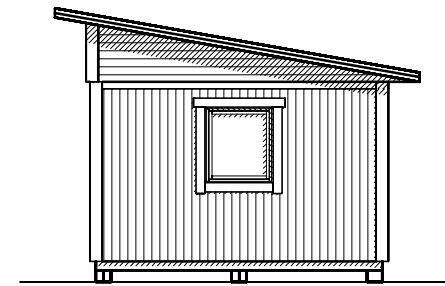

FASAD MOT

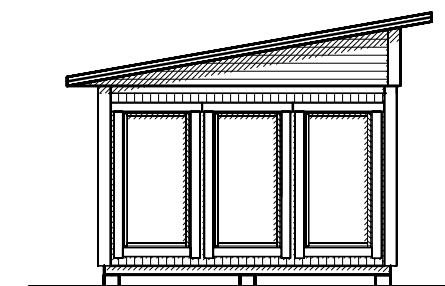

FASAD MOT

BET	ANT	ÄNDRINGEN AVSER	DATUM	SIGN
BYGGLOVSHANDLING				
NYBYGGNAD AV KOMPLEMENTBYGGNAD				
PLAN & SEKTION NJUTA FUNKIS 20-3				
UPPDRAG NR/RITN. NR XXXX		RITAD/KONSTR AV PH		
DATUM 2018-11-02		HANDLÄGGARE		
ANSVARIG		SKALA 1:100, A3	NUMMER A01	BET

